

Keystone Kramming !!

Study Guide to help you pass your keystones !!!!!

—By: Rachel, Kitana , Zaniyah , Angelic and Dejah

Anchors :

1. Cells and Cell Processes
 - a. Basic Biological Principles
 - b. The Chemical Basis for Life
 - c. Bioenergetics: Photosynthesis and Cellular Respiration
 - d. Homeostasis and transport
2. Continuity and Unity of Life
 - a. Cell growth and Reproduction
 - b. Genetics (*Exceeding*)
 - c. Theory of Evolution (*Exceeding*)
 - d. Ecology (*Exceeding*)

Essential Questions:

What role do catalysts play in chemical and biological reactions?

What factors can affect enzyme activity, and how does this impact living things?

What are some examples of enzymes in biological organisms?

How do organisms maintain biological balance between their internal and external environments?

What are the cell structures involved in transport of materials into, out of, and throughout a cell?

How does structure affect function?

Why do organisms need to undergo both mitosis and meiosis?

What are the various ways in which organisms pass down and inherit traits?

How did various species come to be?

What are the evidence of evolution?

How is the ecosystem organized?

How does energy flow in the relationships and interactions in the ecosystem?

How does matter cycle through the ecosystem?

How does the ecosystem respond to

How to study:

First and foremost to be able to answer the essay questions. Brainstorm vocabulary and outline essays. Use chapter summaries, study guides, chapter review questions; notes and additional worksheets. Also watch informational videos to understand these topics.



Basic Biological Principles

All organisms are made up of one or more cells, which are often compared to building blocks. The cell is the smallest living component in any organism. Cells carry specific parts which allow them to carry out life processes. All cells have several characteristic that are important to life. **Eukaryotic** and **Prokaryotic** are the two main types of cells. Prokaryotic cells are unicellular organisms that lack membrane organelles. Which means there DNA is not contained within nuclear membrane, so the DNA is

found in directly in the **cytoplasm**. Prokaryotic cells contain bacteria and archaea (bacteria like) cells, which are found in extreme environments. Eukaryotic cells are more complex and larger than Prokaryotic cells. Eukaryotic cells DNA can be found in the nucleus. Eukaryotic cells have a **cytoskeleton** or protein scaffold that help maintain the large structure of the cell.

These cells can also be **multicellular** or **unicellular**.

Eukaryotic cells contains many membrane-bound organelles with their own function, such as; the **nucleus**, **mitochondria**, **endoplasmic reticulum(ER)**, **golgi apparatus**, and many more. The nucleus holds DNA packaged as chromosomes. The ER is where some ribosomes attach to produce proteins that move outside of the cell. The golgi apparatus is what absorbs and tags the vesicles with an “number” so which vesicles can be placed in the correct place in the cell.

Animal and plant cells are have similar organelles, for example both contain plasma membrane and nucleus. Yet the plant cells

has a few more, such as the **chloroplast**. Chloroplast contain chlorophyll which absorbs the energy of the sunlight, it works like a solar panel.

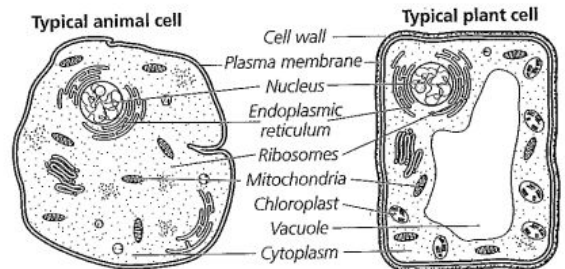

Each organelle in a cell has a specific function.

PROKARYOTIC CELLS VERSUS EUKARYOTIC CELLS

	Prokaryotic Cell	Eukaryotic Cell
Nucleus	No	Yes
Cell Number	Unicellular	Unicellular or multicellular
DNA	Circular chromosome found in cytoplasm	Linear chromosomes contained in nucleus
Examples	Bacteria	Plants, animals, fungi, protists
Plasma Membrane	Yes	Yes
Membrane-bound Organelles	No	Yes
Ribosomes	Yes, small	Yes, large
Cell Wall	Yes	Present in plants and fungi
Cell Diameter	1–10 micrometers (µm)	10–100 micrometers (µm)

Multiple choice

1. Basic unit of life
 - a. Organism
 - b. Cell
2. All multicellular organisms have cells with nuclei and membrane-bound organelles
 - a. Prokaryotic
 - b. Eukaryotic

Fill in the blank

1. Prokaryotic cells _____ organisms.
2. Eukaryotic cells DNA can be found in the _____.
3. Animals cells do not contain ____ but plant cells do.

Open ended Questions

1. What is the difference between Eukaryotic and Prokaryotic cells?
2. How is a plant cell different from the animal cell?

The chemical basis for life

ASSESSMENT ANCHOR		
BIO.A.2 The Chemical Basis for Life		
Anchor Descriptor	Eligible Content	Enhanced Standard
BIO.A.2.1 Describe how the unique properties of water support life on Earth.	BIO.A.2.1.1 Describe the unique properties of water and how these properties support life on Earth (e.g., freezing point, high specific heat, cohesion).	3.1.B.A8 3.1.B.A5 4.2.5.C
Anchor Descriptor	Eligible Content	Enhanced Standard
BIO.A.2.2 Describe and interpret relationships between structure and function at various levels of biochemical organization (i.e., atoms, molecules, and macromolecules).	BIO.A.2.2.1 Explain how carbon is uniquely suited to form biological macromolecules.	3.1.B.A7 3.2.C.A2
	BIO.A.2.2.2 Describe how biological macromolecules form from monomers.	3.1.B.A7 3.1.B.A8 3.1.B.A2 3.1.C.A2 3.1.C.A7
	BIO.A.2.2.3 Compare the structure and function of carbohydrates, lipids, proteins, and nucleic acids in organisms.	3.1.B.A7 3.1.B.A2 3.1.C.A2 3.1.C.A7
Anchor Descriptor	Eligible Content	Enhanced Standard
BIO.A.2.3 Explain how enzymes regulate biochemical reactions within a cell.	BIO.A.2.3.1 Describe the role of an enzyme as a catalyst in regulating a specific biochemical reaction.	3.1.B.A2 3.1.B.A7
	BIO.A.2.3.2 Explain how factors such as pH, temperature, and concentration levels can affect enzyme function.	3.1.B.A2 3.1.B.A7

Water's properties are the results of molecular structure. Water consists of two hydrogen atoms and one oxygen atom, which are held together by **covalent bond**. Atoms in covalent bonds do not always share an equal amount of electrons. For example, in water the oxygen atom pulls on the electrons more than the hydrogen atoms. The unequal sharing of the electrons makes the covalent bond polar. Even though the entire molecule is neutral, different parts carry different charges. Which causes water to be described as a polar molecule. Since it is a polar molecule, water molecules form hydrogen bonds interactions with each other. Many important molecules within a cell are polar. Since water is polar it is able to dissolve other polar molecules and ionic substances, it is known as the universal solvent. However some substances cannot be dissolved, for example **lipids**. Lipids are made of nonpolar molecules, which is the reason they cannot be dissolved. Cohesion is when water molecules attract each other and stick together. Hydrogen bonding interactions with water causes cohesion. **High surface tension** is caused by cohesion, which means more force is required to break the surface of lipids. **Adhesion** is how water sticks to other substances than itself. Adhesion is caused by hydrogen bonding interactions with water and non-water molecules. Water is able to absorb and contain the heat, which is why when you go to the beach the water is cooler than the temperature. This is known as **specific heat**. Large amounts of water absorb and release heat slowly. Once lipids absorb enough heat it begins to evaporate, which causes the heat to become gas. Water has greater **density** than a solid. Once water reaches its freezing point, the molecules arrange themselves into a structure to leave more opening space.

Animal bodies are 65% water. Because water can retain heat well, a large animal would have a large reserve of heat in its body. Once warm, the dinosaur body would remain warm for a long period.

Water and Density

Water has one more unusual property: it has a greater *density* as a liquid than as a solid. When liquid water reaches its **freezing point**, the water molecules arrange themselves into an orderly structure, leaving more space between them. The same amount of matter takes up more volume (space), making it less dense.



b. Nonpolar

c. Covalent bonds

The amount of matter takes up the same amount of space (volume), which causes it to become less dense.

Multiple choice

1. How are the molecules in water held together?

a. Density

b. Adhesion

c. Covalent bond

2. Lipids are made of ___ molecules.

a. Polar

Organic compounds contain carbon and hydrogen, also often contains oxygen, nitrogen, phosphorus, or other elements. Covalent bonds are formed when atoms share electrons. Elements numbers can change by how many covalent bonds can be formed. Single bonds fill four slots, the simplest organic molecule is methane. But carbons are able to form double and triple bonds. The structure of carbon allows the formations macromolecules. Lipids are fats, oils, waxes, and sterols. Fats and oils share the same simple structure of **fatty acid** tails. Fatty acids are long chains of carbon atoms. Fatty acids can be saturated or unsaturated. Saturated fatty acids atoms have a maximum number of single bonds, and unsaturated fatty acids atoms have a fewer than the

maximum of single bonds in saturated (single and double). The plasma membrane is made of **phospholipids**. Nonpolar fatty acid chains (2) make up the tail, and polar phospholipids make up the head.

Carbohydrates consist of carbon, hydrogen, and oxygen. The compound used by cells for energy is called glucose. Which is the simplest type of carbohydrate called monosaccharide. Monosaccharides can link together to form larger macromolecules. Monomers are simple building blocks that join together to form large polymers.

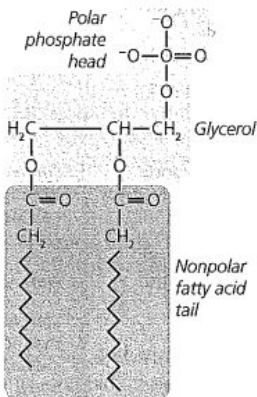

A phospholipid molecule consists of a polar "head" region and a nonpolar "tail."

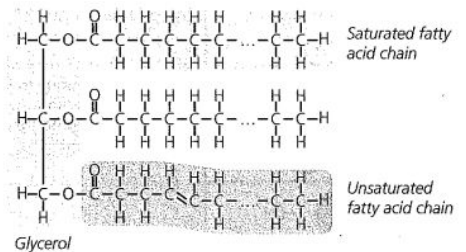

This lipid molecule consists of glycerol attached to three fatty acid chains. Note the difference between the saturated and the unsaturated fatty acids.

True or False

1. Carbohydrates consist of carbon, oxygen and glucose.
2. Fatty acids are a long chain of carbon atoms.

Important polymers in living cells are DNA and RNA (nucleic acids). These polymers are made of **nucleotides**. Nucleotides consist of three parts: a 5-carbon sugar, phosphate group and a variable nitrogen base. Nucleotides are classified in 4 groups A (adenine), G (guanine), C (cystione), T (thymine). The only difference between RNA and DNA is instead of thymine

matching with adenine, adenine matches with uracil.

Proteins are important polymers, that do many different things. Proteins helps transport molecules and other things.

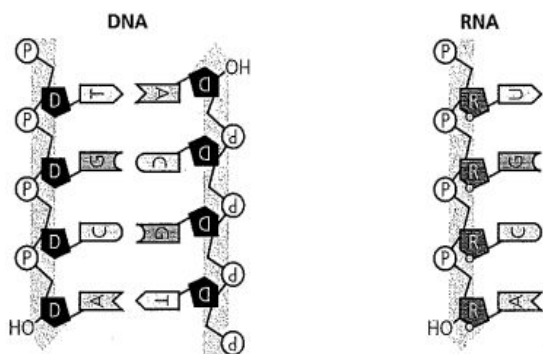

Both DNA and RNA share a phosphate-sugar backbone. DNA is usually found as a double strand. Its nitrogenous bases pair with complementary bases on the partner strand.

True or False

1. Adenine and Cystione match. ___
2. Cystione and Guanine match. ___

Proteins can do

many things throughout the cell, some proteins act as **enzymes**. Enzymes act as catalyst, which help the speeding up the rate of a chemical reaction. Enzymes lower the activation energy of a chemical reaction.

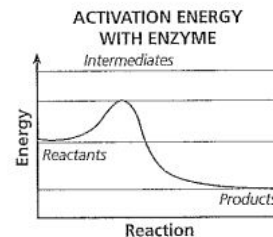
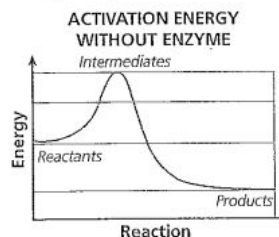

Open ended Questions

1. How do enzymes help the speed the rate of a chemical reaction?

Bioenergetics: Photosynthesis and Cellular Respiration

Keystone Exams: Biology

MODULE A—Cells and Cell Processes

FINAL—April 2014

ASSESSMENT ANCHOR		
BIO.A.3 Bioenergetics		
Anchor Descriptor	Eligible Content	Enhanced Standard
BIO.A.3.1 Identify and describe the cell structures involved in processing energy.	BIO.A.3.1.1 Describe the fundamental roles of plastids (e.g., chloroplasts) and mitochondria in energy transformations.	3.1.B.A2 3.1.B.A5 3.1.C.A1
Anchor Descriptor	Eligible Content	Enhanced Standard
BIO.A.3.2 Identify and describe how organisms obtain and transform energy for their life processes.	BIO.A.3.2.1 Compare the basic transformation of energy during photosynthesis and cellular respiration.	3.1.B.A2 3.1.B.A5 3.1.C.A1 4.1.10.C
	BIO.A.3.2.2 Describe the role of ATP in biochemical reactions.	3.1.B.A2 3.1.C.A1 3.1.C.A2

Eligible Content may be assessed using knowledge and/or skills associated with the Nature of Science.

ATP

ATP is a small molecule that provides energy for reactions that happen throughout the cell. It is useful as a basic energy source for all cells. During a reaction, when ATP is bound by the last phosphate group. It releases energy when broken. When broken down it releases energy as a form of heat. ATP is made up of phosphate groups and ADP, when breaking down and re-forming the bonds between its phosphate groups, it creates more ATP.

Cellular respiration

Without the constant supply of ATP, cells wouldn't be able to perform the actions they need too based on the lack of energy. To assemble ATP you need a process called Cellular respiration. This product breaks down the molecule called glucose, that comes from food. During cellular respiration there are 3 important stages that happen. There is *glycolysis*, and this part happens inside the cytoplasm. While there the glucose molecules get broken down into smaller molecules. During this part of the process oxygen. after the process was complete there was only 2 ATP molecules from that one glucose molecule.

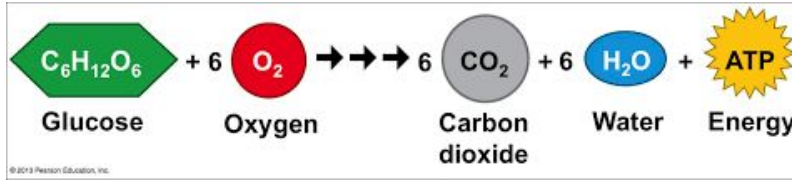

Aerobic respiration is the involvement of oxygen in respiration. The use of oxygen in aerobic respiration, is the breakdown of oxygen and glucose, to make carbon dioxide and water. Other types of respiration that use oxygen and its called anaerobic respiration. There are different types of anaerobic respiration, like fermentation.

Fermentation which carries out glucose before the aerobic respiration stage. It changes glucose into ethanol and and carbon dioxide(lactic acid).

The second and third stages of cellular respiration happen in the matrix of the mitochondria. Then the Krebs cycle happens which is the breaking down fatty acids and amino acids. The third stage is when hydrogen ions travel across the inner membrane. When the travel across the inner membrane, it signals an enzyme called ATP synthase, thats attached to the inner membrane of the mitochondria. It synthesis ATP from ADP and Phosphates and the ions leave the matrix, then more ATP is created.

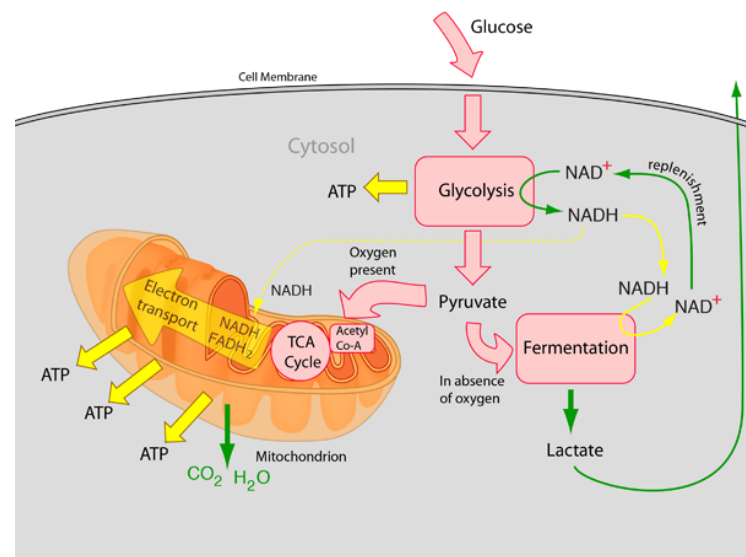

Photosynthesis

Photosynthesis uses the energy of sunlight to convert water and carbon dioxide into high energy sugars and oxygen. Some AT is produced directly by Photosynthesis. The glucose made from photosynthesis provide energy for the plant. The plants can use it immediately or store it as starches for later use. Among the most important factors that affect photosynthesis our temperature, light intensity, and the availability of water.

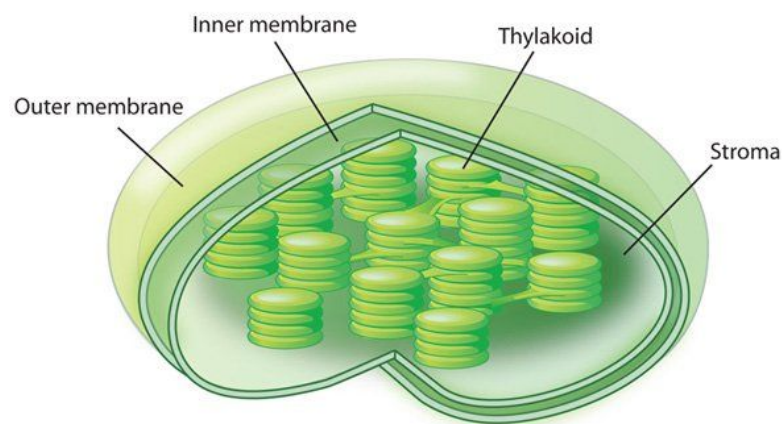

Chloroplasts and photosynthesis : chloroplast is where photosynthesis happens in eukaryotic

cells. A chloroplast has two membranes surrounding the fluid held inside (stroma). The fluid has disks (thylakoids) inside it, the membrane of the thylakoids are important to photosynthesis. They contain chlorophyll which has a pigment that captures sunlight, that is used for energy in the photosynthesis process.

In most plants the process happens in the leaves, so they need carbon dioxide and water as raw/necessary materials for photosynthesis. The leaves take in the carbon dioxide from the atmosphere through openings called stomata, they are small pores on the underside of leaves. They use it to take in carbon and release oxygen. Plants take in water from the soil through the roots inside the ground. The water travels to the cells in the leaves through tube-like vascular tissues.

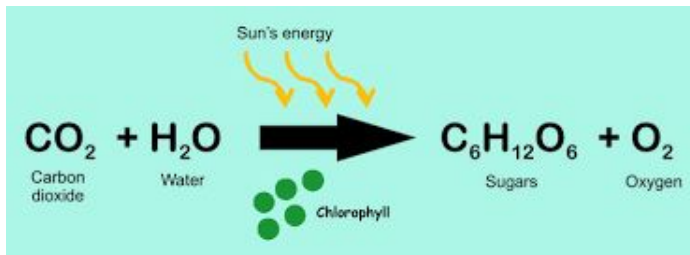

Two stages of photosynthesis : the two stages of photosynthesis happen in two different parts of the chloroplasts. The first stage is light-dependent reactions and it happens in the thylakoids that contain chlorophyll (energized by sunlight). It produces ATP and other energized molecules. Then the split of water molecules (used in the second stage) and releases oxygen from the leaf.

the other is light-independent reactions where no light is used and it consumes carbon dioxide in the stroma of the chloroplast. The light-dependent reactions energy is being depended on in this stage. Using the water (hydrogen atoms and electrons). It converts the carbon dioxide into organic molecules such as glucose.

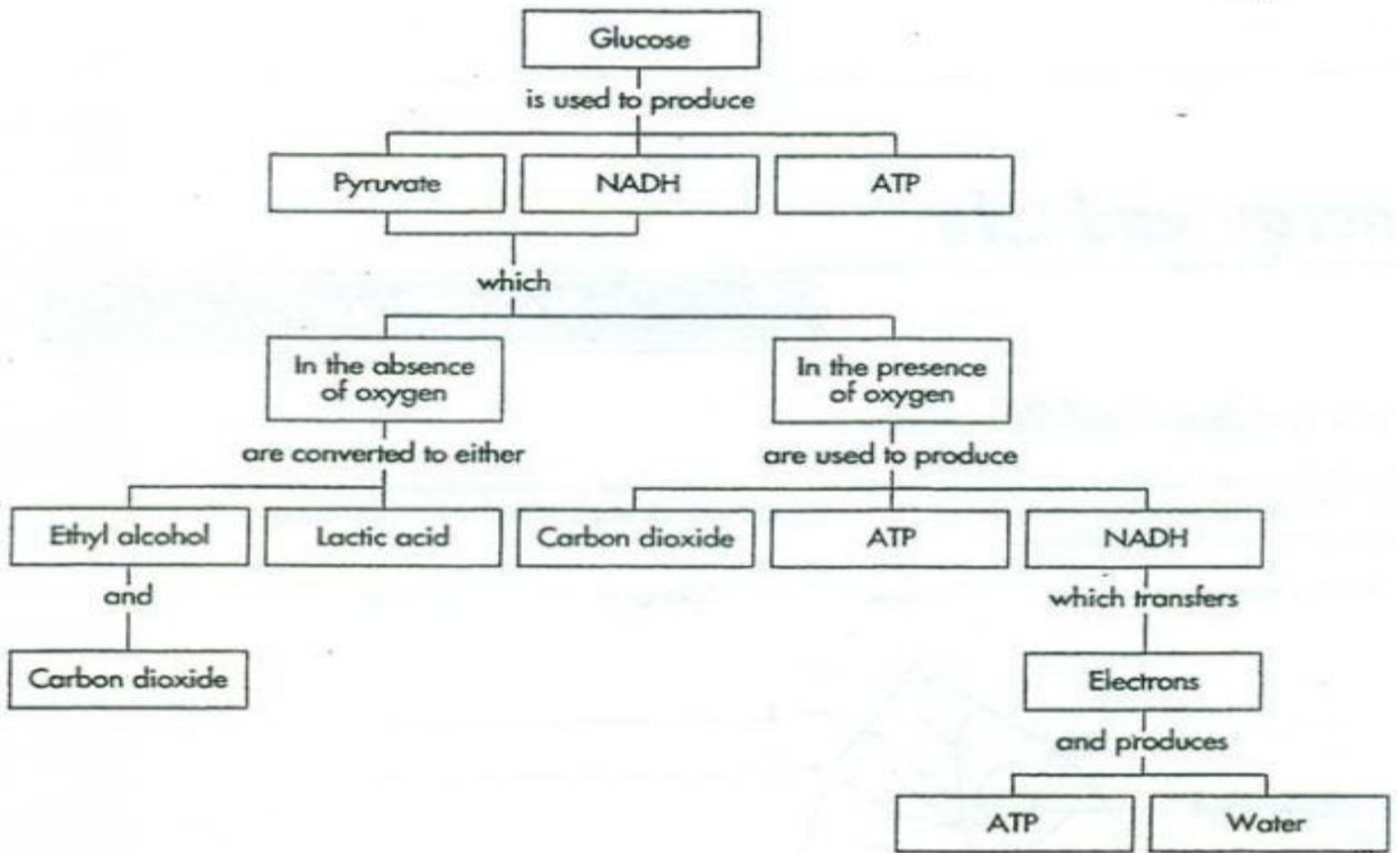

Photosynthesis and Cellular Respiration

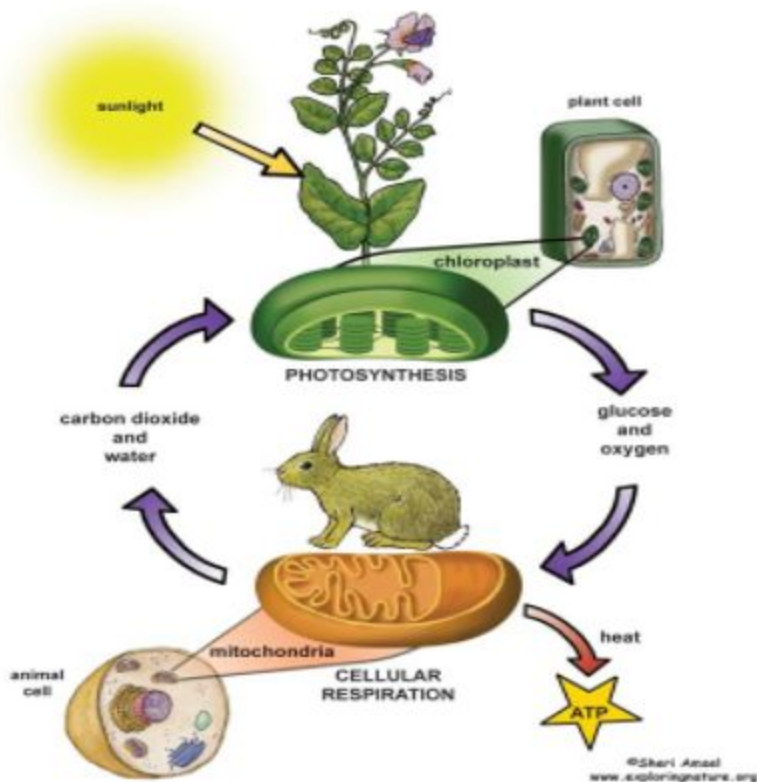

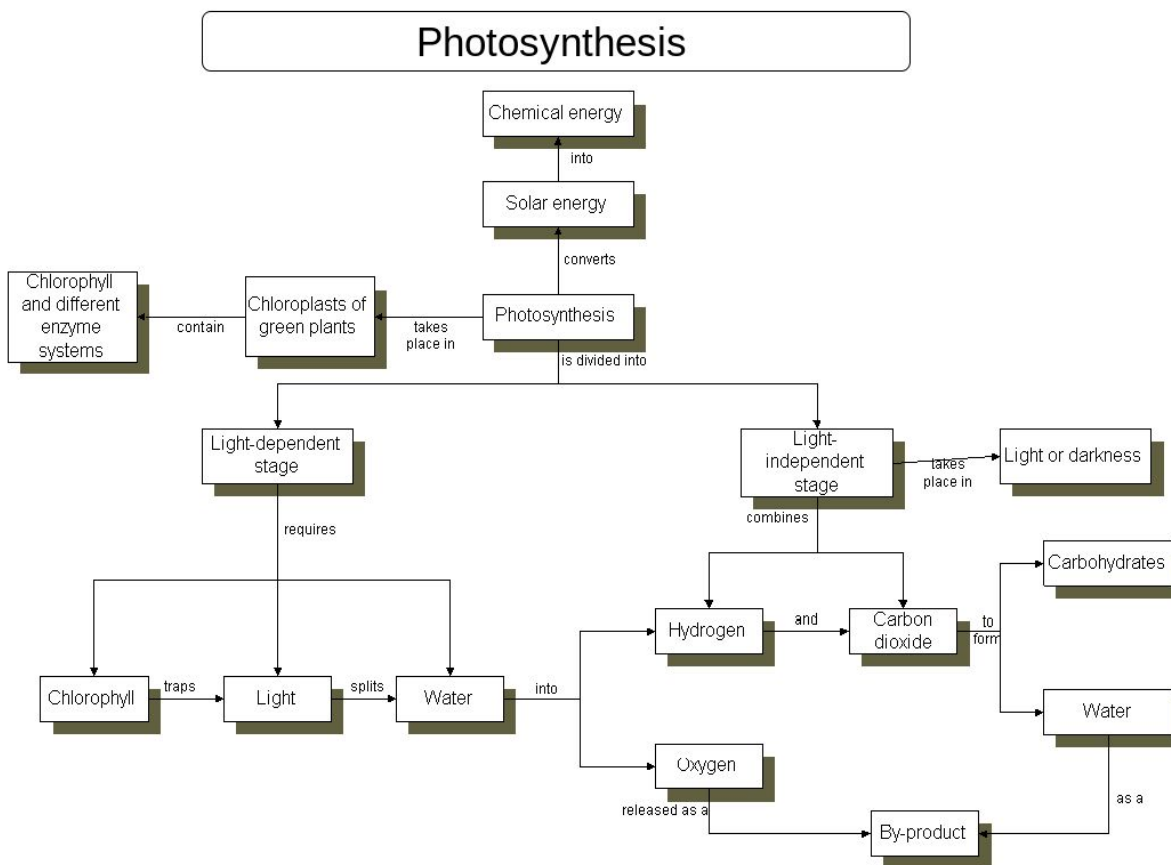

ATP and Energy questions : [answer key](#)

1. What are the different energy molecules in the cell? Describe the energy storage capacity of each and relate this to their function in living organisms.

2. What are the three parts of an ATP molecule?

- A. adenine, thylakoid, and phosphate group
- B. stroma, grana, and thylakoid
- C. adenine, ribose, and phosphate group
- D. NADH, NADPH, and FADH

3. Energy is released from an ATP molecule when:

- A. a phosphate group is added
- B. a phosphate group is removed
- C. adenine bonds to ribose
- D. the molecule is exposed to sunlight

4. How do heterotrophs and autotrophs differ in the way they obtain energy

Questions for photosynthesis :

1. Which organelle is involved in photosynthesis? List and describe the parts of this organelle.
2. Explain what happens to energy during photosynthesis. How does energy enter into photosynthesis? In what form does it exist during photosynthesis?
3. Plants absorb energy with light-absorbing molecules called:
A. stroma B. grana C. thylakoids D. pigments
4. What is the primary pigment involved in photosynthesis? Why do plants also contain accessory pigments?
5. A student exposed one plant to only red light and another to only green light. Which should grow better and why?

Cellular Respiration and Fermentation:

1. What are the products and reactants of cellular respiration? Where does the reaction take place in cells?
2. How is energy transformed during cellular respiration?
3. Why are photosynthesis and cellular respiration considered opposite reactions?

Genetics (Exceeding)

ASSESSMENT ANCHOR		
BIO.B.2 Genetics		
Anchor Descriptor	Eligible Content	Enhanced Standard
BIO.B.2.1 Compare Mendelian and non-Mendelian patterns of inheritance.	BIO.B.2.1.1 Describe and/or predict observed patterns of inheritance (i.e., dominant, recessive, co-dominance, incomplete dominance, sex-linked, polygenic, and multiple alleles).	3.1.B.B5
	BIO.B.2.1.2 Describe processes that can alter composition or number of chromosomes (i.e., crossing-over, nondisjunction, duplication, translocation, deletion, insertion, and inversion).	3.1.B.B1 3.1.B.B2 3.1.B.B3 3.1.C.C2
Anchor Descriptor	Eligible Content	Enhanced Standard
BIO.B.2.2 Explain the process of protein synthesis (i.e., transcription, translation, and protein modification).	BIO.B.2.2.1 Describe how the processes of transcription and translation are similar in all organisms.	3.1.B.B1 3.1.B.B3 3.1.B.B5 3.1.C.B3 3.1.C.C2
	BIO.B.2.2.2 Describe the role of ribosomes, endoplasmic reticulum, Golgi apparatus, and the nucleus in the production of specific types of proteins.	3.1.B.A5 3.1.B.B3 3.1.B.B5 3.1.C.B3
Anchor Descriptor	Eligible Content	Enhanced Standard
BIO.B.2.3 Explain how genetic information is expressed.	BIO.B.2.3.1 Describe how genetic mutations alter the DNA sequence and may or may not affect phenotype (e.g., silent, nonsense, frame-shift).	3.1.B.B1 3.1.B.B3 3.1.B.C2 3.1.C.B3

Key words:

Allele -an Alternative form of a gene for each variation of a trait of an organism.

cell cycle - series of events that cells go through as they grow and divide

Codominance -A condition in which neither of two alleles of a gene is dominant or recessive, results in both traits being expressed

crossing over -Process in which homologous chromosomes exchange portions of their chromatids during meiosis.

Cytokinesis -Division of the cytoplasm during cell division

DNA replication -The process in which DNA makes a duplicate copy of itself.

Gamete -Sex cell

Gene -A segment of DNA on a chromosome that codes for a specific trait

gene recombination -A natural process in which a nucleic acid molecule (usually DNA but can be RNA) is broken and then joined to a different molecule; a result of crossing-over during meiosis

incomplete dominance- Situation in which one allele is not completely dominant over another allele, results in a blend of two traits

Inheritance -The process in which genetic material is passed from parents to their offspring.

Interphase -Cell grows, performs its normal functions, and prepares for division; consists of G1, S, and G2 phases

Meiosis -Cell division that produces reproductive cells in sexually reproducing organisms

Mitosis -Cell division (PMAT) of the nucleus. Final product is 2 cells that are exactly like the parent cell.

Nondisjunction -Error in meiosis in which homologous chromosomes fail to separate.

recessive inheritance -A weak allele that is only expressed in a homozygous genotype

semiconservative replication- Method of DNA replication in which parental strands separate, act as templates, and produce molecules of DNA with one parental DNA strand and one new DNA strand

sex-linked trait -a trait that is determined by a gene found on one of the sex chromosomes, such as the X chromosome or the Y chromosome in humans (most commonly Y)

genotype-An organism's genetic makeup, or allele combinations.

phenotypes-physical expression of a gene

Genes come in different versions, called Alleles. Inheritance is determined by “factors” that are passed from one generation to the next is genes. Each gene controls one trait with two contrasting characters. The Principle of dominance basically states that some alleles are neither dominant or recessive. Organisms with a dominant allele for a specific form of a trait will always have that specific trait . Organism with two recessive alleles for a specific form of a trait will also have just that specific trait . Segregation is the separation of



alleles, During formation of gametes (sex cells) each allele is separated DNA.

In most cases, traits are polygenic, meaning that they are determined by a number of different gene located on different chromosomes. Just as there are different versions of a trait- there are different versions/ alleles of genes that can determine those traits. The gene that determines height in pea plants has two different alleles- one causing a tall phenotype and one causing a short one. A phenotype is the appearance of a trait. The body cells for most sexually reproductive organisms contain two alleles of each gene. An organism can inherited two identical or different alleles from a gene. The combination of alleles in an organism's cells is considered the genotype. If a pea plant inherits two dominant alleles then, it expresses the dominant phenotype. If it inherits two recessive alleles, it expresses a recessive phenotype. A recessive allele is expressed only if the individual inherits two copies of the allele. A heterozygous (different alleles) organism inherits one of each allele.

Homozygous – have two identical alleles – true-breeding

Heterozygous – have two different alleles – hybrid – carrier

Phenotype – physical feature (attached or detached earlobes)

Genotype – genetic makeup (EE or Ee or ee – represent genes)

Based on the genes give to the organism by the parents are inherited from the bases of it being dominant or recess if. To explain this, scientist came up with the principles of probability. It can be used to predict the outcomes of genetic crosses. The outcome of genetic crosses can be predicted by the Punnett square, a diagram that helps determine gene combinations that might result from a genetic cross. (Capital letters represent dominant alleles; lower case letters represent lower case letters.) Punnett squares show the probability that each offspring will have a given genotype.

Not all genes have one dominant and one recessive allele. Some alleles may show incomplete dominance, meaning that a heterozygous individual has a phenotype that differs from those with either homozygous genotype. The inheritance of flower color in snapdragons is an example of incomplete dominance. The allele R results in the red flower phenotype and the allele r results in white flowers. However, heterozygous flowers are pink, meaning that the phenotype is “in between”. Alleles may also show co-dominance, meaning that heterozygotes express both the dominant and recessive phenotypes, rather than a

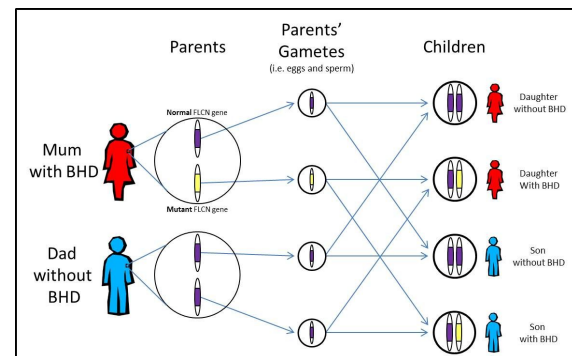

blend of the two. Some genes have more than two possible alleles that is called codominance .Codominance (AB blood type, sickle cell) – both alleles contribute to the phenotype of the organism

Besides codominance there can be, r two genes, alleles segregate independently. That is independent assortment ,genes segregate independently and do not influence each other’s inheritance. What this does for genes is that genes with different traits can segregate independently during the formation of gametes.

The role of dominance is also key. incomplete dominance, when one allele is not completely dominant over the other.

In humans and many other animals, a single pair of chromosomes, called the sex chromosomes, determines an individual’s sex. The human sex chromosomes are the X and Y chromosomes. An XX chromosome is female, while an XY chromosome is male. The X chromosome is much larger, and contains way more genes, than the Y. Most genes on the X chromosomes Determine traits that have nothing to do with being male or female. Traits governed by the genes on a sex chromosome are called sex-linked traits.sex linked traits – traits from genes carried on X or Y chromosomes, genes on X usually occur at a higher rate in boys, females can be carriers and males cannot. Non-sex chromosomes are called autosomes. Recessive sex-linked traits governed by genes in the X chromosome are observed more often in males than in females.

How to : Punnett squares

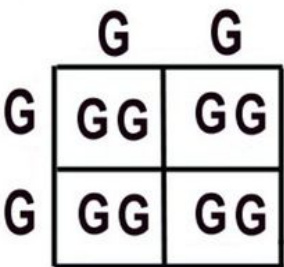

Two bunnies meet at the in the enchanted forest , fall in love, and get married that same night. They decide to do the deed right away . The mom bunny has a big fluffy tail (TT) while the dad has a small round flat tail (tt). What is the chance that the first child will have a flat tail?

T = fluffy tail t = flat tail

Cross TT (above boxes) X tt(side of boxes)

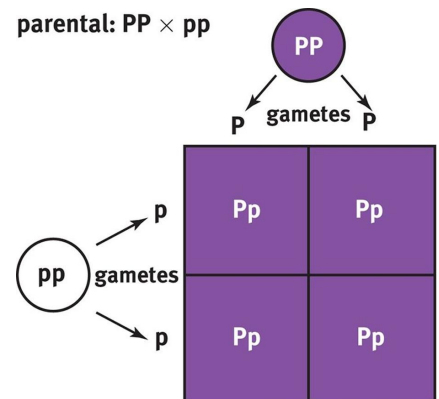
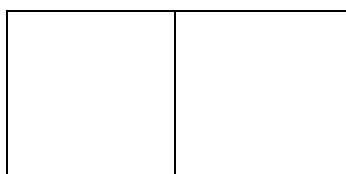

F₁ genotypic ratio: 100% Pp (heterozygous)

F₁ phenotypic ratio: 100% purple

--	--

Open-ended Question: [Answer key](#)

A guinea pig owner genetically crosses a female guinea pig with a lilac coat. To a male guinea pig with a gold coat. The resulting offspring is argente, which means there are lilac and gold hairs intermixed in the coat of the guinea pig. The genes for coat color in guinea pigs are codominant.

Part A: Although the owner has them in all three colors, He prefers argente guinea pigs over lilac or gold guinea pigs. Use the

Punnett square to show a cross that would produce only argente offspring.

Cross GG(gold) X LL(lilac)

Part B: Explain how an argente guinea pig results from one lilac - and one gold-coated parent. In your explanation, use letters to represent genes. Be sure to indicate what colors the letters represent.

Part C: Predict the possible genotypes and phenotypes of the offspring produced from two argente cattle.

Genetics

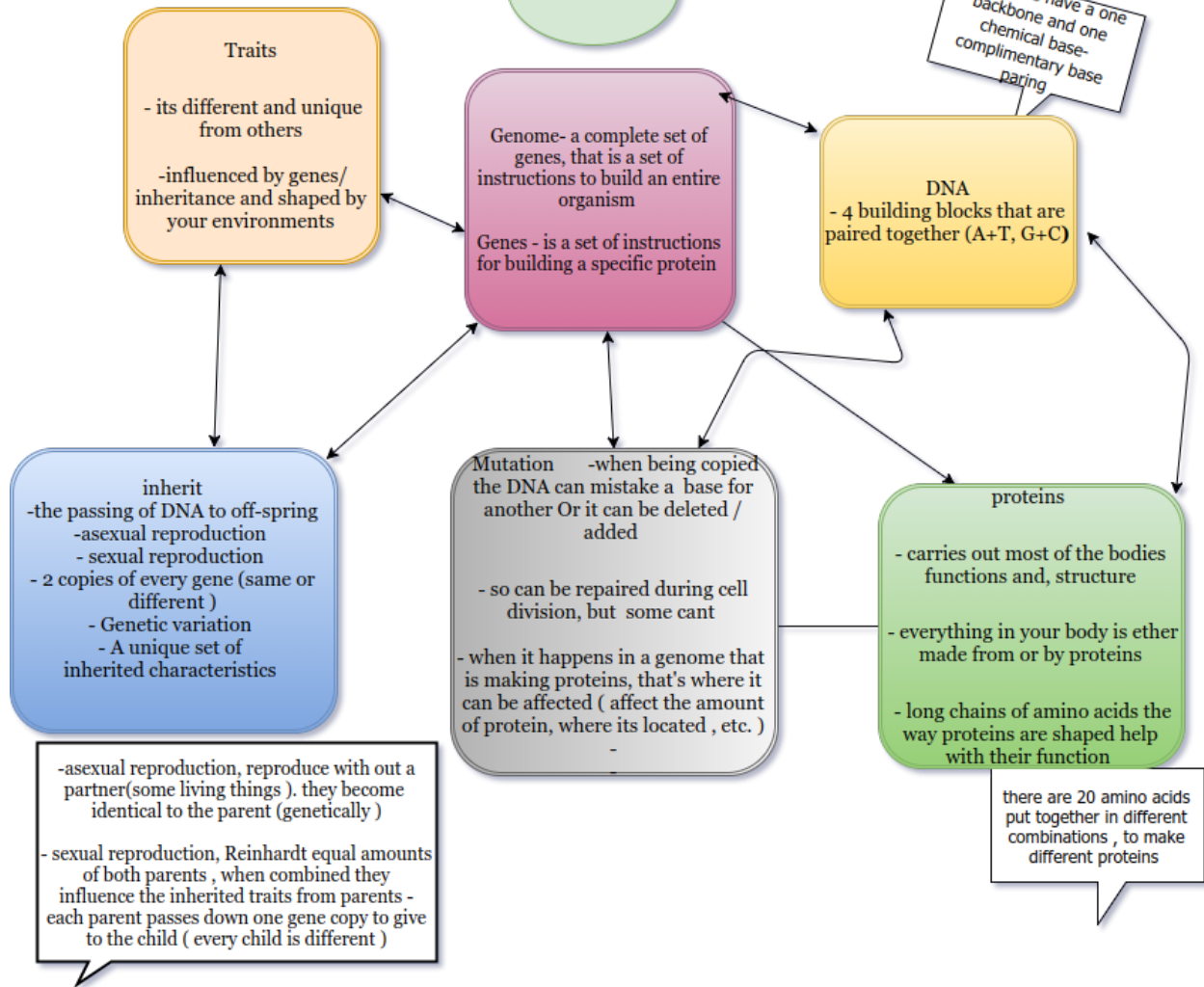

Homeostasis & Cell Transport!

ASSESSMENT ANCHOR		
BIO.A.4 Homeostasis and Transport		
Anchor Descriptor	Eligible Content	Enhanced Standard
BIO.A.4.1 Identify and describe the cell structures involved in transport of materials into, out of, and throughout a cell.	BIO.A.4.1.1 Describe how the structure of the plasma membrane allows it to function as a regulatory structure and/or protective barrier for a cell.	3.1.B.A5 3.1.B.A2 3.1.B.A4 3.1.B.A7 3.2.C.A1 3.2.P.B6
	BIO.A.4.1.2 Compare the mechanisms that transport materials across the plasma membrane (i.e., passive transport—diffusion, osmosis, facilitated diffusion; and active transport—pumps, endocytosis, exocytosis).	3.1.B.A5 3.1.B.A2 3.1.B.A7 3.2.C.A1 3.2.P.B6
	BIO.A.4.1.3 Describe how membrane-bound cellular organelles (e.g., endoplasmic reticulum, Golgi apparatus) facilitate the transport of materials within a cell.	3.1.B.A5 3.1.B.A2
Anchor Descriptor	Eligible Content	Enhanced Standard
BIO.A.4.2 Explain mechanisms that permit organisms to maintain biological balance between their internal and external environments.	BIO.A.4.2.1 Explain how organisms maintain homeostasis (e.g., thermoregulation, water regulation, oxygen regulation).	3.1.B.A8 3.1.B.A5 4.5.4.D 4.2.4.C

Lesson:

Homeostasis ("standing still"), is a process by which cells maintain the internal conditions that they need to support life. This can be generalized to the heat that our bodies generate to keep us warm and support chemical reactions or the microscopic movements of molecules across cell membranes. This is what powers that larger changes that keep our bodies in equilibrium. As a matter of fact, most of the processes to maintain homeostasis in cells occurs in the form of diffusion of materials across membranes. However, there are several different ways that this can take place. Depending on the type and size of molecules diffusing across, different processes can take place.

Osmosis is the process by which water diffuses through a membrane. When water moves passively through a cell membrane, that's osmosis. The main constraint on osmosis is **concentration**. Concentration is the ratio of solute material in a solution to the solvent that it is dissolved in. Concentration can be called "salt water", which means literally "Concentration of Salt Water."

Water will naturally move from an area with a lower concentration of solutes to an area with a higher concentration in order to achieve **equilibrium**, or a state where the concentrations are balanced throughout. Water will move through any membrane it can as long as it is moving to

an area with a higher concentration. These areas are called **hypertonic**, and areas with lower concentrations are called **hypotonic**.

Osmosis is vital to life because of its function in maintaining equilibrium inside and outside of a cell. However, conditions on a cell can sometimes cause problems. If there is a high concentration of say, salt outside a plant, all the water from inside plant cells will diffuse outside of the plant and cause the plant cells to shrink in a process called **plasmolysis**.

Passive Transport is any method of transporting materials that does not use energy. Because of this, it is usually only found when particles move down their concentration gradient, from an area of higher concentration to an area of lower concentration. One of the most common types of Passive Transport is **Osmosis**, which is responsible for moving water through a cell's membrane. Other kinds of particles can also move through the cell membrane as well. They are usually small molecules such as oxygen and simply pass between the spaces in the lipid bilayer of a cell's membrane.

Active transport, on the other hand, requires energy to function. This energy is usually provided in the form of ADP or ATP, types of sugar molecules produced in cells from more complex sugars. As mentioned before, Active Transport is usually used to move atoms or molecules UP the concentration gradient, as in from an area of lower concentration to an area of higher concentration.

Endocytosis is a process by which cells can take in large particles and deposit them into the cell.

Endocytosis can be used to bring large particles, such as glucose, into a cell. Also, this process can be used by white blood cells to ingest viruses or bacteria and then digest them in their lysosomes. **Exocytosis** is very similar to endocytosis except that it deposits materials from inside the cell on the outside instead of the other way around. Vesicles are formed in the Golgi Bodies, filled with materials to be sent outside the cell, and then fuse with the cell membrane and release their contents outside of the cell.

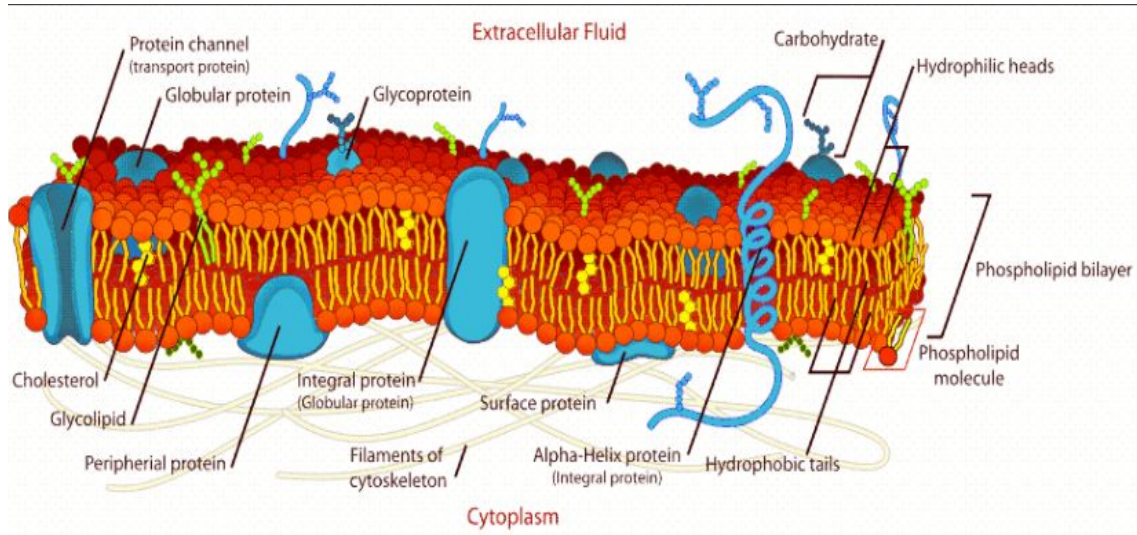

Flow Chart:

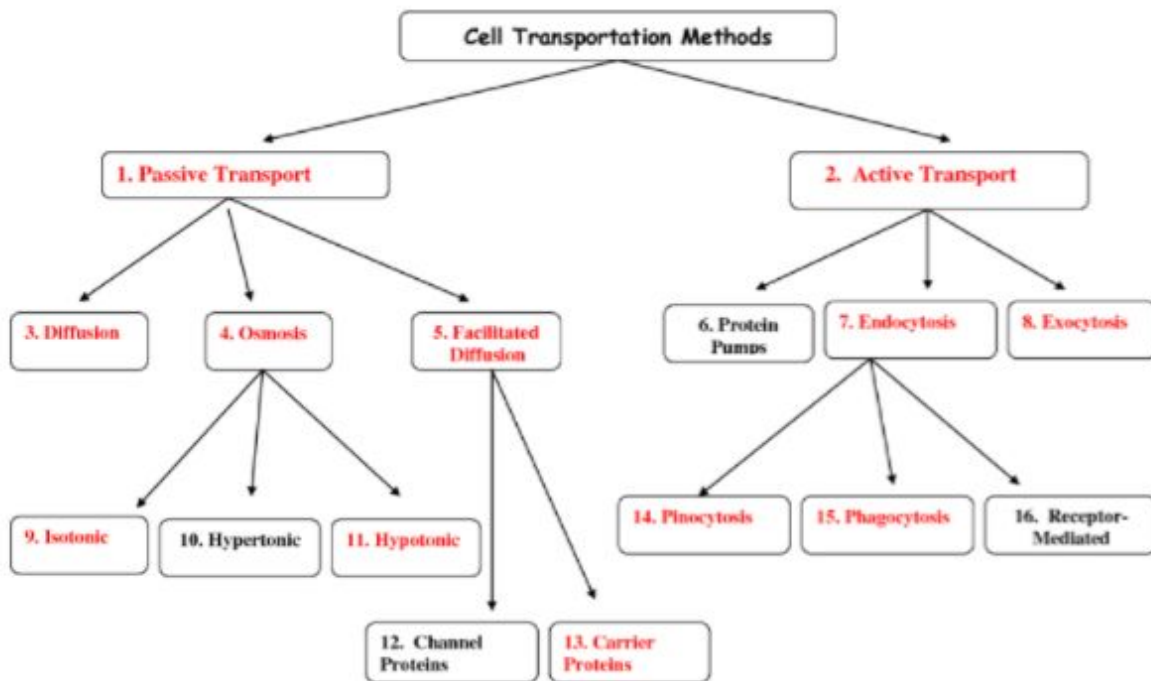

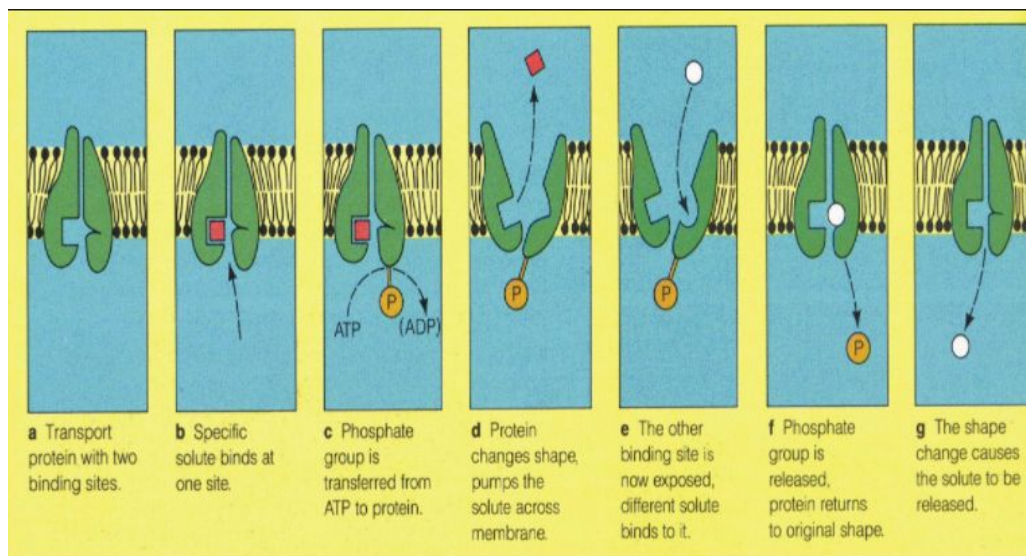
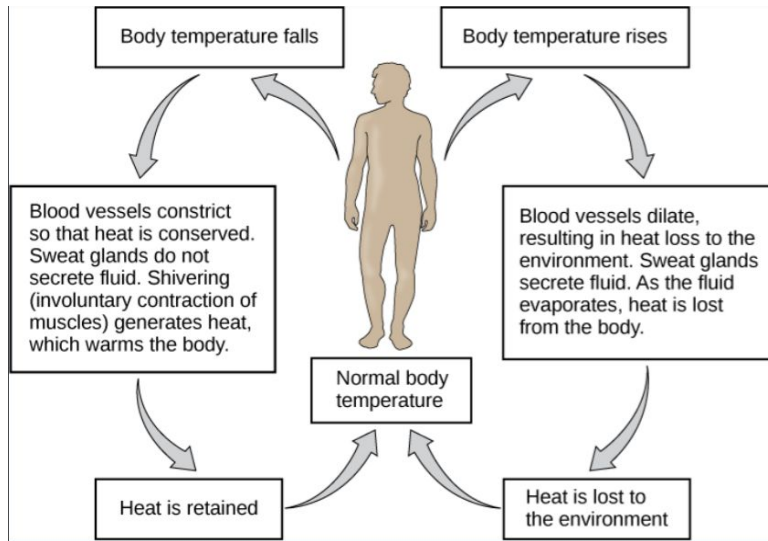

Practice:

(3 open ended, true or false,

Fill In ([Answer key](#))

1. Cells take in _____ from their environment.
2. Cells release _____.
3. A cell has a _____ around it that works like a window screen.

4. The way things move through a cell membrane depends on: A- _____
B- _____ C- _____
5. The movement of substances through the cell membrane without the input of energy is called _____.
6. _____ types of passive transport can occur.
7. _____ is one type of cellular passive transport.
8. When equilibrium is reached, _____ stops.
9. The diffusion of water through a cell membrane is called _____.
10. Smaller molecules can pass easily through the cell membrane by diffusion.
Some will pass through small openings formed by _____.
11. When the number of molecules is equal in the two areas, _____ is reached.

Did you
get it
right?



OPEN ENDED 1 ([Answer Key](#)) :

The picture shows the transfer of molecules across the cell membrane.

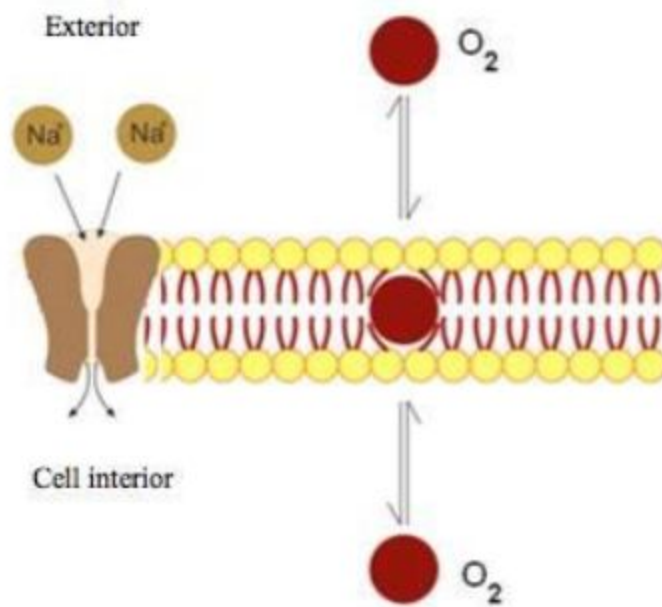

Question: Describe the process by which O₂ molecules pass through the membrane.

Rubric-

2 pts: Two key elements are present.

1 pt: One key element is present.

0 pts: No key elements are present.

MULTIPLE CHOICE (Answer Key) :

1. What are hormones?
 - a. Your nerves
 - b. Chemical messengers from your body
 - c. Your body's sweat

2. Which of these body parts release hormones?
 - a. Hormones
 - b. Muscles
 - c. Hypothalamus

3. When your body tries to return back to normal it is ..
 - a. Positive feedback
 - b. Neutral feedback
 - c. No feedback
 - d. Negative feedback

4. What hormone works to regulate glucose levels in the body?
 - a. Glucagon
 - b. Adrenaline
 - c. Insulin

5. What system generates heat when the body temperature drops too low?
 - a. Muscular
 - b. Digestive
 - c. Skeletal

6. Someone who cannot produce insulin has....
 - a. Diabetes
 - b. Hypothalamus
 - c. Cancer

7. If an organism does maintain homeostasis death can occur
 - a. False

b. True

8. An person who is often time sick would have a problem maintaining homeostasis in which of the following major body systems?

- a. Digestive System
- b. Circular System
- c. Immune System
- d. Nervous System

9. A person having a heart attack would have a problem maintaining homeostasis in which of the following major body systems?

- a. Skeletal System
- b. Respiratory System
- c. Circulatory System
- d. Reproductive System

10. When a person's blood sugar goes above the set point, which organ releases Insulin into the bloodstream?

- a. Pancreas
- b. Heart
- c. Liver
- d. Lungs

Cell Growth & Reproduction!

ASSESSMENT ANCHOR		
BIO.B.1 Cell Growth and Reproduction		
Anchor Descriptor	Eligible Content	Enhanced Standard
BIO.B.1.1 Describe the three stages of the cell cycle: interphase, nuclear division, cytokinesis.	BIO.B.1.1.1 Describe the events that occur during the cell cycle: interphase, nuclear division (i.e., mitosis or meiosis), cytokinesis.	3.1.B.A4 3.1.B.A5 3.1.B.B2 3.1.B.B3 3.1.B.B5 3.1.B.C2 3.1.C.C2
	BIO.B.1.1.2 Compare the processes and outcomes of mitotic and meiotic nuclear divisions.	3.1.B.A4 3.1.B.A5 3.1.B.B2 3.1.B.B3 3.1.B.B5 3.1.B.C2 3.1.C.C2
Anchor Descriptor	Eligible Content	Enhanced Standard
BIO.B.1.2 Explain how genetic information is inherited.	BIO.B.1.2.1 Describe how the process of DNA replication results in the transmission and/or conservation of genetic information.	3.1.B.B1 3.1.B.B3 3.1.B.B5 3.1.B.C2 3.1.C.C2
	BIO.B.1.2.2 Explain the functional relationships between DNA, genes, alleles, and chromosomes and their roles in inheritance.	3.1.B.B1 3.1.B.B5 3.1.B.B2 3.1.B.B3

Reproduction:

Cellular reproduction is a process by which cells duplicate their contents and then divide to yield multiple cells with similar, if not duplicate, contents.

Mitosis:

Mitosis is a nuclear division resulting in the production of two somatic cells having the same genetic complement (genetically identical) as the original cell. Mitosis appears as sister chromatids joined at the centromere. Mitosis is divided into 4 stages. Which is

Prophase- nuclear envelope disintegrates and a spindle of microtubules forms. Centrioles may help organize the spindle as in this animal cell. The chromosomes begin to move toward the midplane of the spindle

Metaphase- When they are on the midplane with centromeres attached to spindle fibers

Anaphase- centromeres separate and the sister chromatids, now termed chromosomes, are pulled toward opposite poles of the spindle.

Telophase- a nuclear envelope forms around each set of

chromosomes, the spindle disappears and the chromosomes decondense.

Meiosis:

The ultimate goal of the process of meiosis is to reduce the number of chromosomes by half to produce gametes. This must occur prior to sexual reproduction. The final products of meiosis, four daughter cells, each contain one chromatid from each original homologous pair, for a total of two chromosomes.

Haploid- one set of chromosomes-half diploid

Diploid- two sets of chromosomes

Meiosis- A two phase nuclear division that results in the eventual production of gametes with half the normal number of chromosomes.

Allele- An allele is a version or flavor of a gene.

Gamete - specialized cell (egg or sperm) used in sexual reproduction containing half the normal number of chromosomes of a somatic cell. Each gamete holds one chromosome from each pair and only one allele of each gene.

Gene Recombination -A natural process in which a nucleic acid molecule is and then joined to a different molecule; a result of crossing-over.

Every species of organism has a characteristic chromosome number, for humans, this number is 46. The chromosomes are found in homologous pairs. Each member of a pair is inherited from one parent. A human cell contains two copies of each of 23 different chromosomes for a total of 46 chromosomes. Gametes are different, each one holds one chromosome from each pair, and therefore only one allele of each gene. When a sperm and an egg join, the offspring inherits one chromosome for each homologous pair from each parent. Gametes are produced by meiosis. Meiosis produces gametes through two stages or rounds of cell division. Meiosis 1 is when the number of chromosomes is halved. Homologous pairs of chromosomes are separated in this stage. Meiosis 2 is when the sister chromatid that make up a chromosome separate. The daughter cells still have the same normal number of chromosomes, but now they are unreplicated. Early in the first stage of meiosis, homologous chromosomes pairs up and this is where crossing over occurs. **Crossing over** is the exchange of genetic materials, it makes each sister chromatid different and unique. It increases the genetic variation in a species.

A cell passes through 3 main stages in its lifetime which is, **interphase**, **nuclear division**, and **cytokinesis**. The longest of these is interphase. During interphase, the cell grows and prepares for cell division. An important stage is S phase. S stands for **synthesis**, because this is when a cell synthesizes a copy of its DNA. The form of nuclear division that produces most cells of the body

is mitosis, which produces an exact replica of the nucleus and all its chromosomes. The final stage of the cell cycle is cytokinesis, in which the original parent cell splits into two daughter cells. For a cell to form 2 genetically identical daughter cells, it must first duplicate its nucleus. Before DNA replication, each chromosome consists of two DNA arms with a centromere in the center. These are called **Sister Chromatids**. Sister chromatids separate during mitosis, the M phase, and for a brief period of time, the cell contains twice the normal chromosome number. DNA replication is carried out by enzymes. An enzyme DNA helicase binds to a site on the double stranded DNA and begins to separate the two strands. Then, the enzyme **DNA polymerase** moves along each strand, pairing free nucleotides to the nucleotides in the strand. The pairing of new nucleotides follows complementary base pairing rules which are, “ A pairs with T and C pairs with G”. As a result, each “new” double strand contains one strand that came from the original DNA and one newly synthesized strand. For this reason, DNA replication is called **semiconservative**.

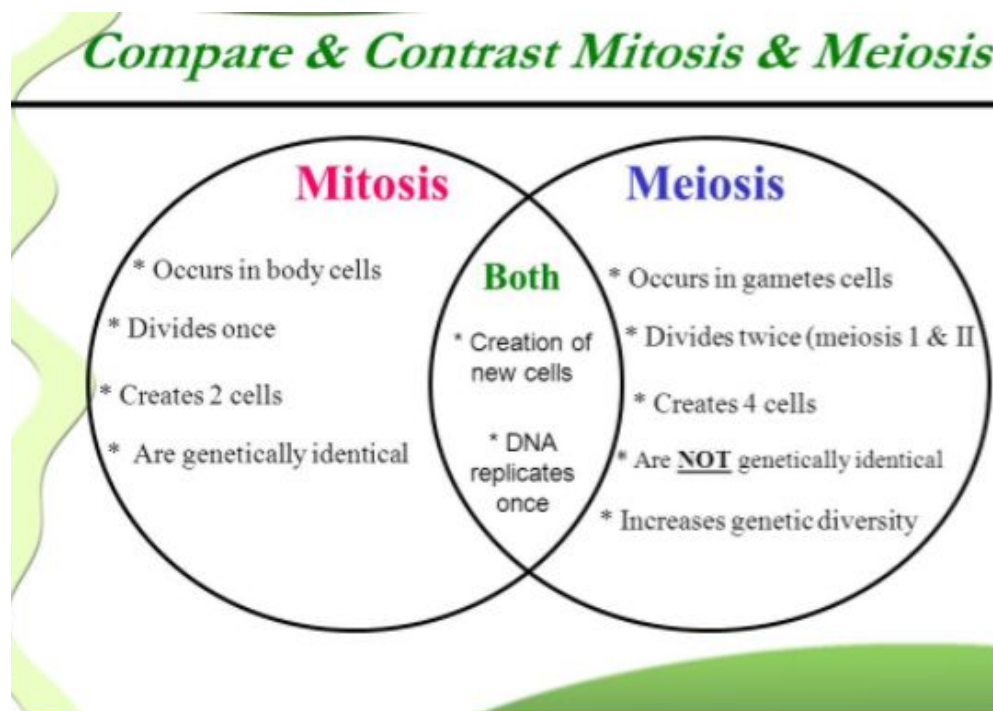

Need more help? Here is a Video:

<https://youtu.be/qH4WUUQ5pOI>

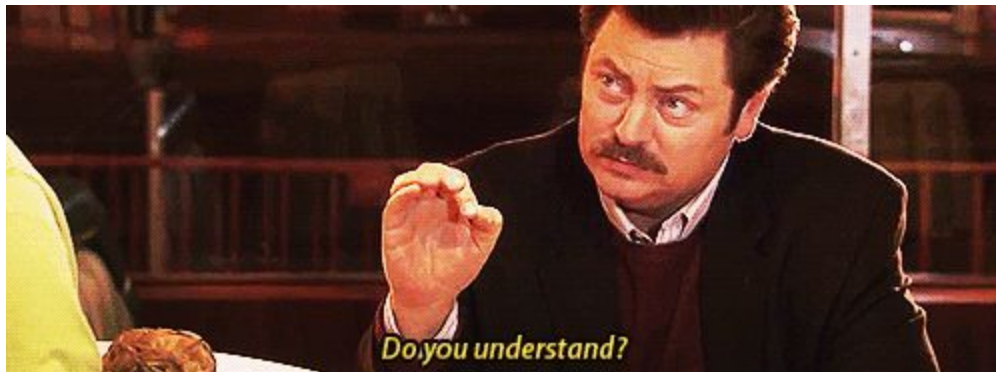

It's okay if you don't, Here is more diagrams to explain the process of mitosis and meiosis!

Diagrams:

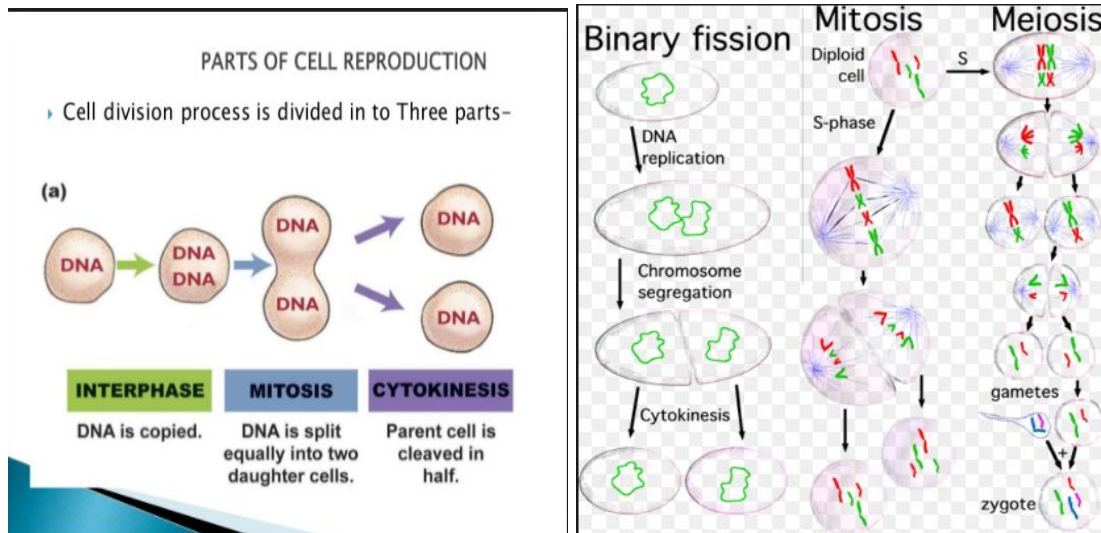

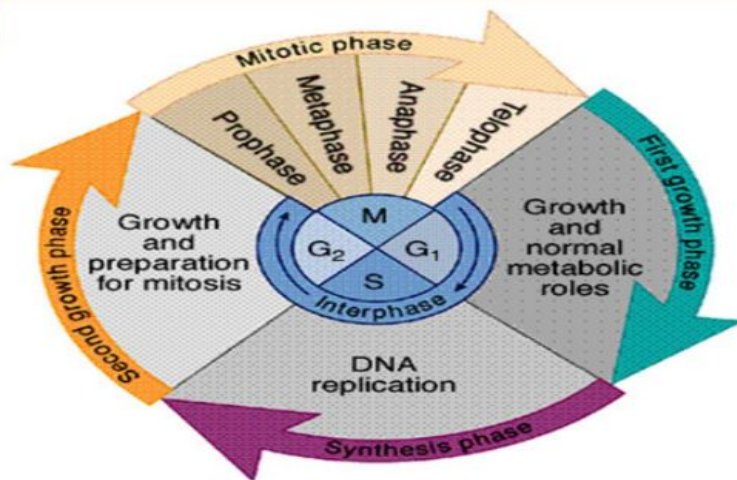

B. Diagram the cell cycle

Mitosis and Meiosis Fill In: ([Answer Key](#))

1. Gametes has _____ chromosomes.
2. Mitosis makes _____ daughter cells.
3. Meiosis makes _____ daughter cells
4. Chromosomes line up in a _____ line.
5. _____ occurs in prophase 1 one of meiosis.
6. _____ chromosomes line up across the middle of the cell.
7. _____ chromosomes becomes invisible.
8. _____ sister chromatids separate into individual chromosomes.
9. In the _____ part of the process, DNA is copied.
10. These are the cell division process steps in order _____ , _____ , _____ .

True or False (Answer Key):

1. Cells of organisms must replicate for ..?
 - a. Growth
 - b. Repair of damaged cells
 - c. Replacement of dying cells.
 - d. All of the above

2. Before cells can be divided, what must be copied?
 - a. DNA
 - b. Cell wall
 - c. Mitochondria
 - d. Cytoplasm

3. The division of the nucleus is known as
 - a. G1
 - b. G2
 - c. Mitosis

4. In the G1 stage of the cell cycle, the cell
 - a. Grows
 - b. Matures
 - c. Carries on normal activities
 - d. All of the above

5. A human cell has 46 chromosomes before mitotic division. How many chromosomes will the daughter cells after mitosis.
 - a. 12
 - b. 46
 - c. 23

6. The stages of mitosis in order
 - a. Prophase, Metaphase, Anaphase, Telophase
 - b. Anaphase, Prophase, Telophase, Metaphase
 - c. Prophase, Anaphase, Metaphase, Telophase

7. Why do we need meiosis?
- To double the number of chromosomes going into sex cells
 - To triple the number of chromosomes going into sex cells
 - To halve the number of chromosomes going into sex cells
8. A cell with only half the normal number of chromosomes is called a _____ cell.
- Haploid
 - Prokaryotic
 - Diploid

Open Ended 1: ([Answer Key](#))

Using an opening and closing sentence, compare and contrast Mitosis and meiosis. Be sure to include evidence to support your claim.

Open Ended 2: ([Answer Key](#))

What happens during each stage of mitosis?

Ecology (*Exceeding*) :

BIO.B.4 Ecology							
Anchor Descriptor	Eligible Content	Enhanced Standard					
BIO.B.4.1 Describe ecological levels of organization in the biosphere.	BIO.B.4.1.1 Describe the levels of ecological organization (i.e., organism, population, community, ecosystem, biome, and biosphere).	4.1.4.A	4.1.10.A	4.4.6.A	4.5.3.D		
	BIO.B.4.1.2 Describe characteristic biotic and abiotic components of aquatic and terrestrial ecosystems.	4.1.7.A 4.1.3.A	4.1.4.B 4.2.10.A	4.1.4.C 4.4.5.C	4.4.3.C		
Anchor Descriptor	Eligible Content	Enhanced Standard					
BIO.B.4.2 Describe interactions and relationships in an ecosystem.	BIO.B.4.2.1 Describe how energy flows through an ecosystem (e.g., food chains, food webs, energy pyramids).	4.1.4.C 4.1.7.C	4.1.10.C 4.1.12.C	4.1.3.C 4.1.5.C	4.1.5.A		
	BIO.B.4.2.2 Describe biotic interactions in an ecosystem (e.g., competition, predation, symbiosis).	4.1.7.A	4.1.10.A	4.5.3.D	4.5.6.D		
	BIO.B.4.2.3 Describe how matter recycles through an ecosystem (i.e., water cycle, carbon cycle, oxygen cycle, and nitrogen cycle).	4.1.4.B 4.1.7.B 4.2.5.A	4.2.7.A 4.3.12.A 4.4.3.C	4.5.4.C 4.5.8.C	4.3.4.D 3.1.B.A2		
	BIO.B.4.2.4 Describe how ecosystems change in response to natural and human disturbances (e.g., climate changes, introduction of nonnative species, pollution, fires).	4.1.10.A 4.1.10.B 4.1.12.A 4.1.4.A 4.1.12.C 4.1.4.E	4.1.7.E 4.1.10.E 4.5.10.D 4.2.8.A 4.2.10.A 4.2.12.A	4.2.10.B 4.2.12.B 4.2.10.C 4.2.12.C 4.3.12.A	4.3.10.B 4.5.10.B 4.5.12.B 4.5.4.C 4.5.7.C		
	BIO.B.4.2.5 Describe the effects of limiting factors on population dynamics and potential species extinction.	4.1.4.A 4.1.10.A 4.1.12.A 4.1.7.E 4.1.10.E	4.2.10.C 4.5.3.D 4.5.5.D 4.5.6.D 4.5.10.D	4.2.10.A 4.2.7.A 4.2.8.A 4.2.10.B 4.4.6.A	4.4.6.B 4.4.3.C 4.4.5.C 4.5.7.B 4.5.7.C		

video <https://www.youtube.com/watch?v=izRvPaAWgyw>

Ecology is the study of the interactions within organisms and environments. Scientist will study how the different biotic and abiotic features in the environment relate to each other. Biotic is the living things in an environment, such as plants, animals, and even humans are included . Abiotic are the nonliving things, for example, temperature, sunlight, etc. These two categories are important to this topic because one wouldn't work without the other. For example in order for anything to produce food they need energy (abiotic). So in this case if there is no energy from the sun then the plants can't survive to provide food for animals, causing the whole food chain to fall a part.

Now in each biome, Large areas with plants & animals that carry common characteristics, their are 4 types of ecology. You have ecosystem, community, population, and organism. An ecosystem is all organisms in non living environment found in one place, where community is All organisms that interact but doesn't include non-living factors. Population is All organisms within one type of species in an area, where organism is one animal. Most of the time they will look at both the biotic and abiotic features in the biome to find a better understanding as to how and why certain animals and plants can live in that environment. An important thing to remember is that an ecosystem will constantly be in change, that is why ecology will always be an important subject.

Energy and the Food Web

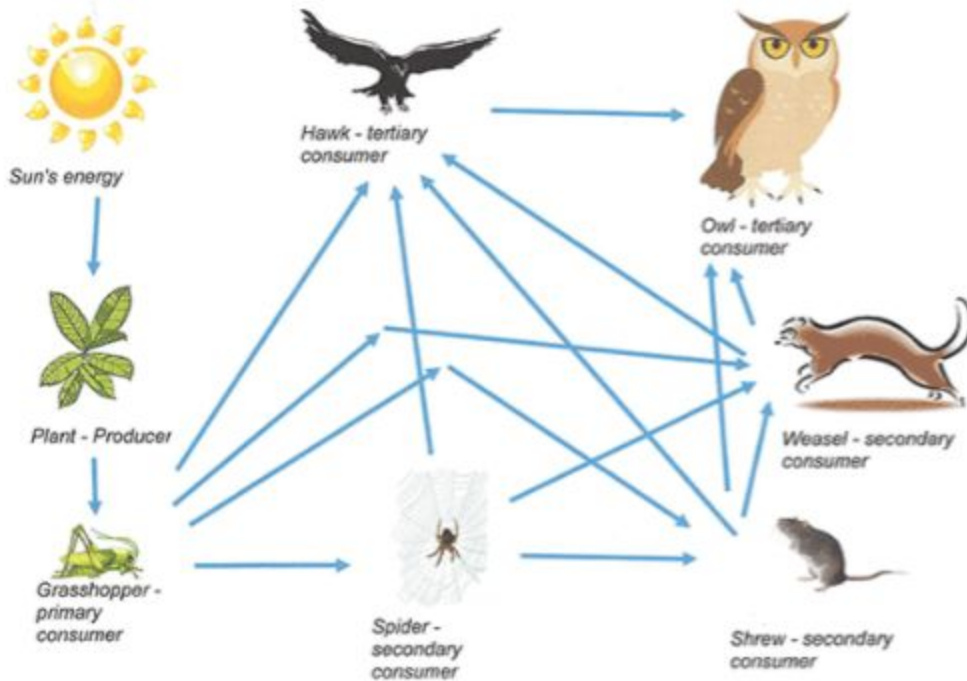

True and false questions !:

1. Ecosystems stay the same throughout all time.

True	False
------	-------

2. Depending on the temperature and how much water there is in a biome dictates what plants and animals will live their.

True	False
------	-------

3. Is the two different categories on what a biome looks like is either biotic or abiotic.

True	False
------	-------

4. Organisms that use the sun in order to make food are called consumers.

True	False
------	-------

5. An important aspect of an ecosystem is energy.

True	False
------	-------

Open Ended Questions:

1. Describe the difference between biotic and abiotic.

The difference between biotic and abiotic is that, biotic is the living things in an environment. Abiotic are the nonliving things, for example, temperature, sunlight, etc.

2. Explain what ecology is in a sentence.

Ecology is the study of the interactions within organisms and environments.

3. Break down the different types of ecology and what they are.

The different types of ecology are ecosystem, community, population, and organism. An ecosystem is all organisms in non living environment found in one place, where community is All organisms that interact but doesn't include non-living factors. Population is All organisms within one type of species in an area, where organism is one animal.

Flow Chart :

<https://www.lucidchart.com/documents/view/4a7afa94-aa8f-4c23-9522-d51e778de5a9>

The Theory of Evolution:

ASSESSMENT ANCHOR		
BIO.B.3 Theory of Evolution		
Anchor Descriptor	Eligible Content	Enhanced Standard
BIO.B.3.1 Explain the mechanisms of evolution.	BIO.B.3.1.1 Explain how natural selection can impact allele frequencies of a population.	3.1.B.C1
	BIO.B.3.1.2 Describe the factors that can contribute to the development of new species (e.g., isolating mechanisms, genetic drift, founder effect, migration).	3.1.B.C1 3.1.B.C2
	BIO.B.3.1.3 Explain how genetic mutations may result in genotypic and phenotypic variations within a population.	3.1.B.C2 3.1.B.B1
Anchor Descriptor	Eligible Content	Enhanced Standard
BIO.B.3.2 Analyze the sources of evidence for biological evolution.	BIO.B.3.2.1 Interpret evidence supporting the theory of evolution (i.e., fossil, anatomical, physiological, embryological, biochemical, and universal genetic code).	3.1.B.C3 3.1.B.C1 3.1.B.B3
Anchor Descriptor	Eligible Content	Enhanced Standard
BIO.B.3.3 Apply scientific thinking, processes, tools, and technologies in the study of the theory of evolution.	BIO.B.3.3.1 Distinguish between the scientific terms: hypothesis, inference, law, theory, principle, fact, and observation.	3.1.B.A9

Flow

chart:<https://www.lucidchart.com/documents/view/67cafa82-f0b7-4712-9630-9da0dc6fb214>

When studying the topic of evolution, it is important to imagine it a certain way. You should always think about how all living things have to adapt. That the world changes and that the living things around it must change too. If they didn't they would have no idea how to survive the way the world is changing. Many things can happen for a living organism to start evolving, and it is not a process that happens overnight. The change happens in each generation of a species. There has been evidence in fossils that some animals today have evolved from animals that have lived hundreds of millions of years ago. For example take this pokemon,

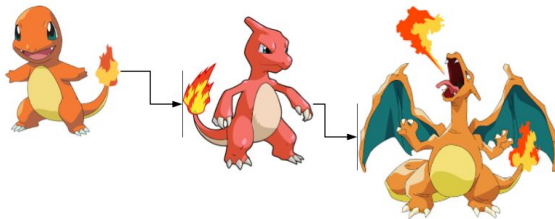

when you play the game you don't automatically get the pokemon fully evolved. It slowly evolves into the highest level of itself. It is the same with living organisms.

Open ended questions

- 1) What two animals do you think evolved from the same animal? Why? Name some characteristics that make you think this.
- 2) Would two species that share the same DNA sequences have the same ancestor? Why?
- 3) Is evolution a fast process?
 - a) Yes
 - b) No
- 4) What has been known to hold evidence of species looking like animals we see today.
 - a) Oceans
 - b) Fossils

- c) Sand
- d) Dirt

Answer Key:

https://docs.google.com/document/d/1sSuKA7loQ-oNxn0ysV-bMANQyTmGx4iu1O6uxciqR_E/edit?usp=sharing

Congratulations!! You are now prepared for the Biology keystone !

